

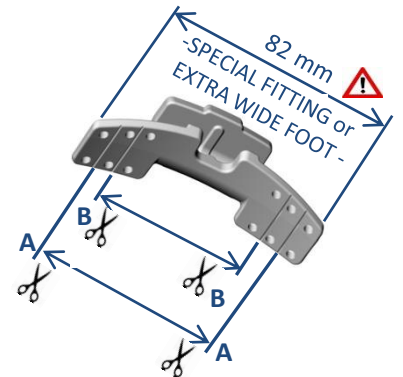

SEE COMMON LACE CLIP FITTING p.6
SEE COMPLETE LACE CLIP INSTALLATION FITTING INSTRUCTION DOCUMENT (DOWNLOAD SECTION WEBSITE)



Turbo Med ORTHOTICS
LACE CLIP FITTING
FS3000 FOOT DROP ORTHOTIC

We recommend stable shoes with firm heelcap, robust fabric and fitted with ridges on sole contour to hold the orthotic in place.

⚠️ **Avoid Minimalist shoes with very light fabric and thin sole!** ⚠️
Keep in mind that the orthotic uses the shoe to lift and stabilize the foot. Poor shoe sturdiness will impair and diminish brace behavior.
(NB, Asics, Brooks, Mizuno, Merrel, Salomon, Keen, Timberland and many other brand are perfect for the brace)

2016-11-11 - FS3000-LACE CLIP FITTING V1.2 (LEGAL)

Turbo Med ORTHOTICS

ASSEMBLY INSTRUCTIONS
(FS3000-SA-L)

FS3000 FOOT DROP ORTHOTIC KIT
SEMI-ASSEMBLED KIT - SIZE LARGE

(SHOE SIZE 11 US -> 16 US Men)

2017-02-09 - FS3000-KT-L ASSEMBLY V1.5 (LEGAL)

FS3000 LARGE KIT - LACE CLIP CUTTING CHART

SHOE SIZE	US-M	11	11.5	12	12.5	13	13.5	14	14.5	15	15.5	16
SHOE SIZE	US-W	///	///	///	///	///	///	///	///	///	///	///
CUTTING POSITION		B	B	B	B	A	A	A	A	A	A	A

⚠️ ****SUGGESTED WIDTH TO BE VALIDATED ON FOOTWEAR****
DO NOT CUT UNTIL FINAL FITTING ON FOOTWEAR

EASY FITTING SHOES FOR FIRST TRIAL...

Regular Sneaker, Tennis Shoe:

(A) Enough eyelets to attach front of the brace
(B) Bulky sole+Ridges for rear friction grip fixation
(C) Robust fabric: We recommend stable shoes with firm heelcap, robust fabric and fitted with ridges on sole contour to hold the orthotic in place. **Avoid Minimalist shoes with very light fabric and thin sole**



ALL DETAILED TECHNICAL INFORMATION ARE AVAILABLE IN DOWNLOAD SECTION OF WEBSITE: ASSEMBLY, SIZING, SHOE FITTING, DONNING DOFFING, THERMOFORMING DOCUMENTS
www.turbomedorthotics.com

1 Hook the lace clip to the front of the orthotic and install temporarily on the shoe.

2 Superimpose on the shoe & validate that the lace clip is close to a set of eyelets.

3 Install 2 Tie-Wraps in forward holes.

4 Pass Tie-wrap ends in Eyelets **NEVER ATTACH AROUND THE LACES**

5 Engage Tie-wraps in locks and install in rear corners or best fit position.

6 Tighten both Tie-Wraps at maximum strength. **STRONG FIXATION OF LACE CLIP IS VERY IMPORTANT**

7 Pull firmly on lace clip and validate that it's solidly anchored to the shoe. **STURDY FIXATION IS A KEY POINT TO ENSURE BEST BEHAVIOR OF THE ORTHOTIC**

8 Cut remaining length of Tie-Wraps.

9



SUGGESTED USEFULL TOOLS

- POWERED DRILL (VARIABLE SPEED)
- DRILL BIT 2.6MM (7/64")
- DRILL BIT 6.5MM (1/4")
- MEASURING CALIPER 300MM OR MEASURING TAPE
- ALLEN KEY 1.5MM (INCLUDED)
- METAL HAND SAW
- BENCH VISE WITH SOFT PAD JAW (PLASTIC OR LEATHER)
- TRAUTMAN SANDER AND CARVER
- PROPANE BLOW TORCH OR HEAT GUN (IF THERMOFORMING REQUIRED)
- SNAP OFF BLADE KNIFE (OLFA, X-ACTO)
- CUTTER PLIER

-PROTECTIVE SAFETY GEAR:
SAFETY GOGGLES, GLOVES, DUST MASK & ALL OTHER PROTECTION REQUIRED BY YOUR HEALTH & SAFETY WORK POLICY

PARTS LIST - ORTHOTIC KIT, SIZE LARGE (FS3000-SA-L)

Item	Qty	PRODUCT CODE	DESCRIPTION
A	1	FS3000-SA-L	ASSEMBLED BRACE BODY, SIZE LARGE
B	1	FS3000-U00-ML	FRONT SHOE SECTION «U» SHAPE, SIZE MEDIUM-LARGE
C	1	FS3000-C00-ML	CALF SECTION, SIZE MEDIUM-LARGE
D	5	FS3000-L00-ML	LACE CLIP ATTACHMENT, SIZE MEDIUM-LARGE
E	6	FS3000-SET-12	M3X12 SET SCREW 18-8 STAINLESS STEEL, 12MM LG
F	1	FS3000-K00-SML	COMPLETE STRAP & CUSHIONS KIT
G	20	FS3000-ZZZ-001	TIE-WRAP BLACK 18 LBS/4" LONG
H	1	FS3000-ZZZ-002	HIGH-TORQUE HEX-L-KEY 1.5MM FOR M3 SET SCREW

FS3000 LARGE KIT - LENGTH ADJUSTMENT CUTTING CHART												
SHOE SIZE	US-M	11	11.5	12	12.5	13	13.5	14	14.5	15	15.5	16
SHOE SIZE	US-W	///	///	///	///	///	///	///	///	///	///	///
FINAL LENGTH	L (mm)	217	220	223	226	230	233	237	241	244	248	252
CUTTING REF	X	37	40	43	46	50	53	58	62	65	69	73

"X" ACCURATE FOR W=96mm (ORIGINAL BRACE & ASSESS. TOOL WIDTH)
 ADD 2-4 mm TO ENLARGE BRACE WIDTH ("W")
 SUBSTRACT 2-4 mm TO REDUCE BRACE WIDTH ("W")

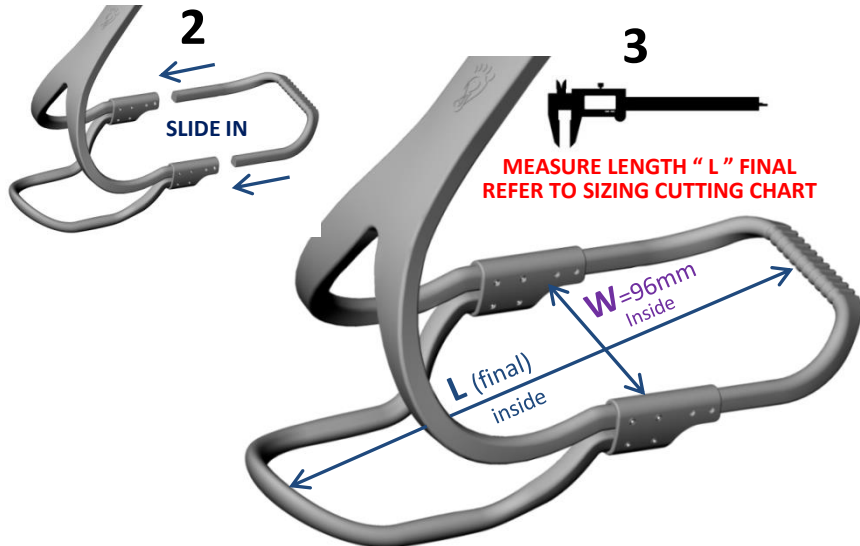
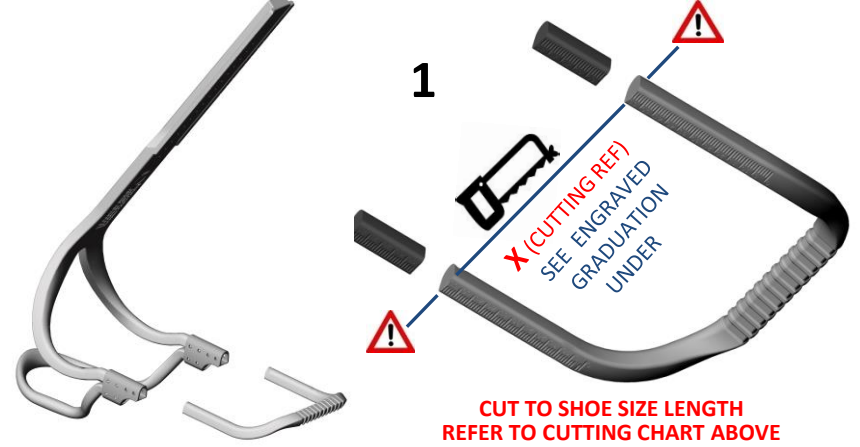

BASIC ORIGINAL BRACE WIDTH "W" = 96mm
 WE SUGGEST TO REFORM "W" WIDTH SLIGHTLY WIDER FOR SHOE SIZE LARGER THAN 13.5 US-M (SEE * & "W" CHART BELOW)
SEE THERMOFORMING GUIDELINE IF REQUIRED

FS3000 LARGE KIT - SUGGESTED BRACE WIDTH												
SHOE SIZE	US-M	11	11.5	12	12.5	13	13.5	14	14.5	15	15.5	16
WIDTH	W(mm)	96	96	96	96	98	98	98	100	100	100	102
						*	*	*	*	*	*	*

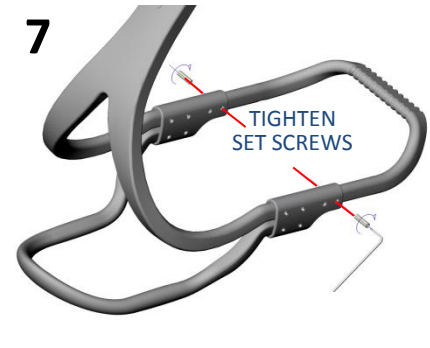
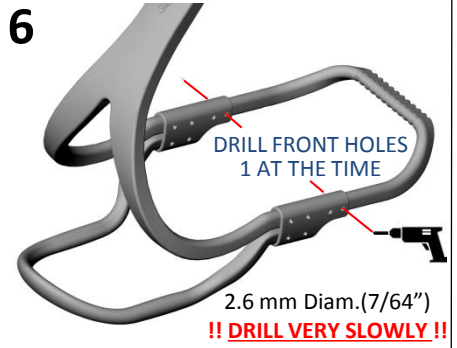
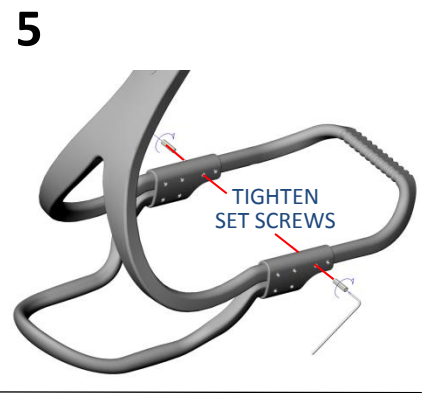
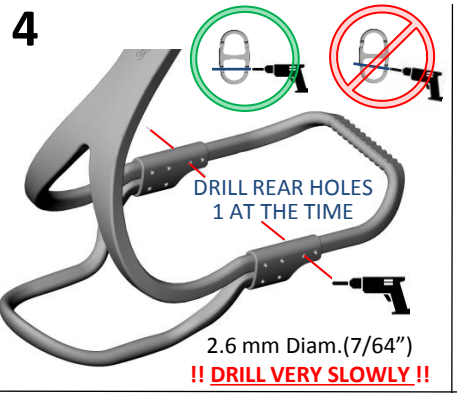

FS3000 LARGE KIT - CALF SUPPORT ADJUSTMENT CHART												
SHOE SIZE	US-M	11	11.5	12	12.5	13	13.5	14	14.5	15	15.5	16
SHOE SIZE	US-W	///	///	///	///	///	///	///	///	///	///	///
CALF HEIGHT	H (mm)	275	280	280	286	286	292	292	295	295	300	300

SUGGESTED HEIGHT (Y) PROPORTIONAL TO SHOE SIZE - WE SUGGEST TO TAKE MEASUREMENTS ON PATIENT

